



# PRODUCT CATALOGUE

# ECO RANGE

Designed to provide reliability, durability and safety, ECO is the affordable range of light switches and wiring accessories – the perfect fit for any type of residential or commercial buildings.



## ECO RANGE

### Your first choice, simple and convenient

Whether it's in a kitchen, a living room or a child's room, ECO is your first choice, simple and convenient.



01

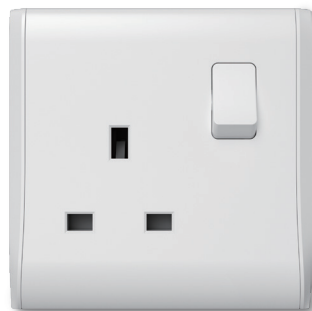

02

01 White switch

02 White socket



# ECO RANGE

## Features & benefits



Screwless design  
Easy to install



Gentle  
touch feeling



High quality  
Anti-flame PC

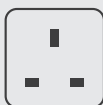

Socket mechanical  
lifespan >15000 times

Flip-open panel makes the installation more direct, more effective and more convenient as well as presenting us a better appearance.

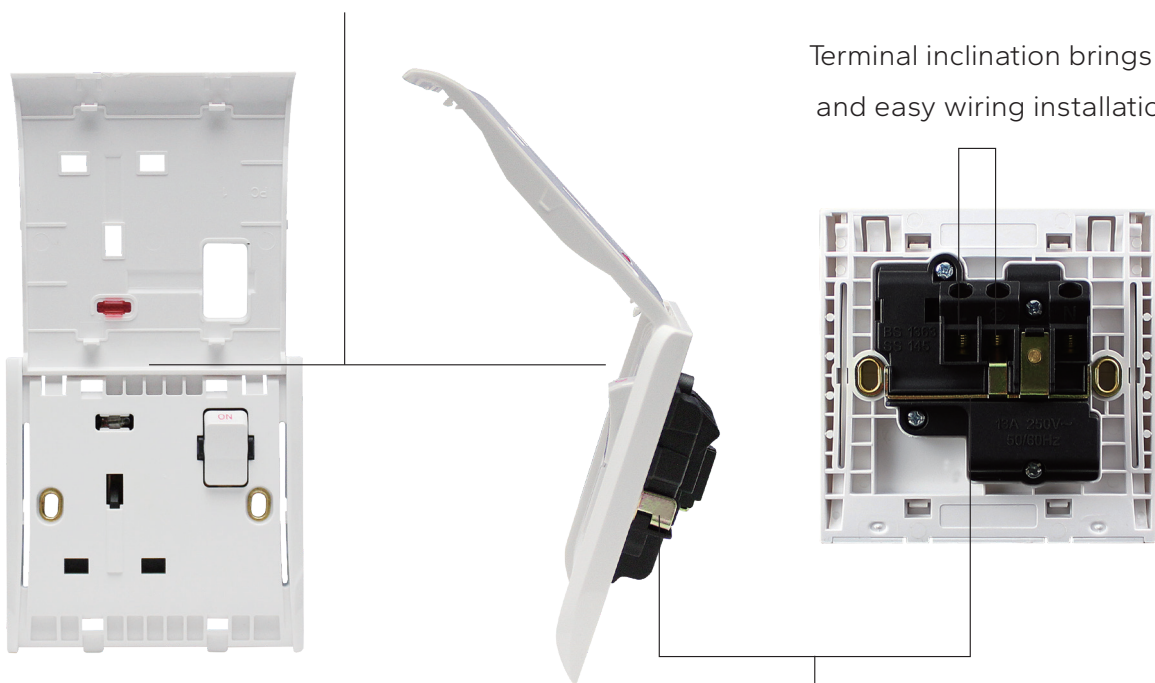

Terminal inclination brings quick and easy wiring installation

Line pressing screw with waisted shank in case shedding

Available in nine colors – white, off white, beige, silver, grey, black, champagne, light golden and Light wooden – the minimalist of the ECO switches and socket outlets sets new standards for convenient design.



01



02



03



04



05



06



07



08



09

- 01 White
- 02 Off white
- 03 Beige
- 04 Silver
- 05 Grey
- 06 Black
- 07 Champagne
- 08 Light golden
- 09 Light wooden

# Product overview

## Switches

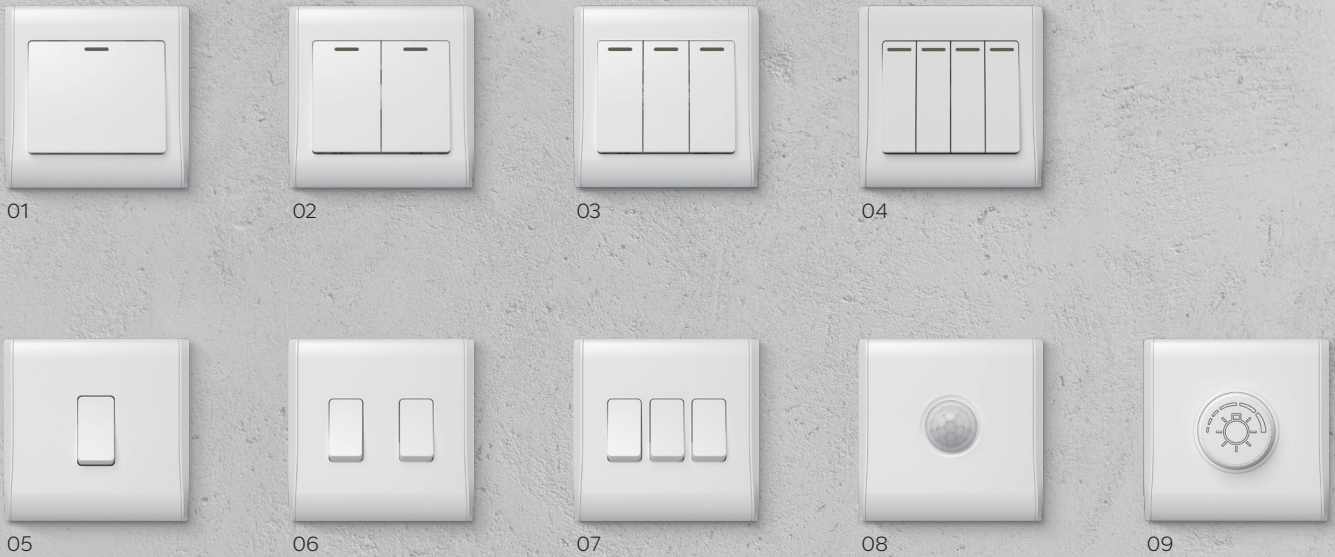

See product picture	Type	Description	Technical Data	Flush-mounted Box Dimension
<b>Switch</b>				
01	NMP201F	1 gang 1 way switch (wide dolly) + fluorescent strip	10AX	35mm
01	NMP202F	1 gang 2 way switch (wide dolly) + fluorescent strip	10AX	35mm
02	NMP203F	2 gang 1 way switch (wide dolly) + fluorescent strip	10AX	35mm
02	NMP204F	2 gang 2 way switch (wide dolly) + fluorescent strip	10AX	35mm
03	NMP205F	3 gang 1 way switch (wide dolly) + fluorescent strip	10AX	35mm
03	NMP206F	3 gang 2 way switch (wide dolly) + fluorescent strip	10AX	35mm
04	NMP264F	4 gang 2 way switch (wide dolly) + fluorescent strip	10AX	35mm
05	NMP201	1 gang 1 way switch	10AX	35mm
05	NMP202	1 gang 2 way switch	10AX	35mm
06	NMP203	2 gang 1 way switch	10AX	35mm
06	NMP204	2 gang 2 way switch	10AX	35mm
07	NMP205	3 gang 1 way switch	10AX	35mm
07	NMP206	3 gang 2 way switch	10AX	35mm
05	NMP213	1 gang 2 way intermediate switch	10AX	35mm
08	NMP223	Sensor switch	10AX	35mm
09	NMP250	250W 1 gang dimmer switch, single pole	10AX	47mm

## Product overview

### Switches/Data outlets/Accessories

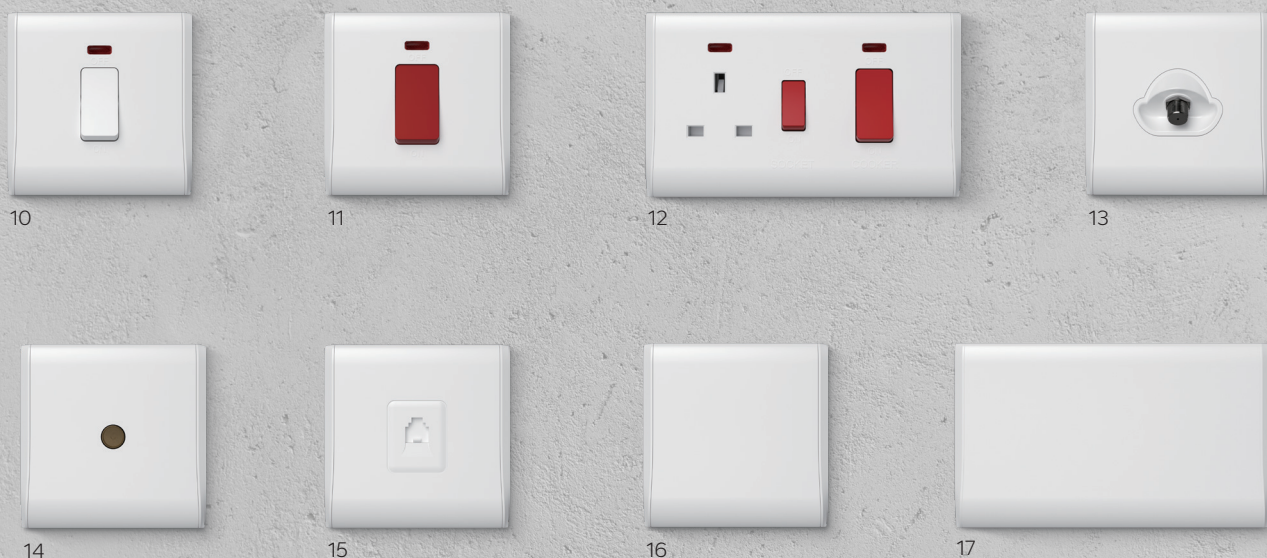

See product picture	Type	Description	Technical Data	Flush-mounted Box Dimension
<b>Switch</b>				
10	NMP224	20A 1 gang switch, DP + neon	20A	35mm
11	NMP227	45A 1 gang switch, DP + neon	45A	35mm
12	NMP231	45A 1 gang switch + neon + 13A switched socket + neon	45A/13A	35mm
<b>Co-axial &amp; Satellite Outlets</b>				35mm
13	NMP165	1 gang satellite socket (45° angle)	F-type	35mm
<b>Tel &amp; Data Outlets</b>				
14	NMP632	1 gang co-axial socket	5-1000MHz	35mm
15	NMP652	1 gang telephone socket	RJ11	35mm
<b>Accessories</b>				
16	NMP601	1 gang blank plate	-	35mm
17	NMP602	2 gang blank plate (3×6)	-	35mm



## Product overview

### Socket outlets

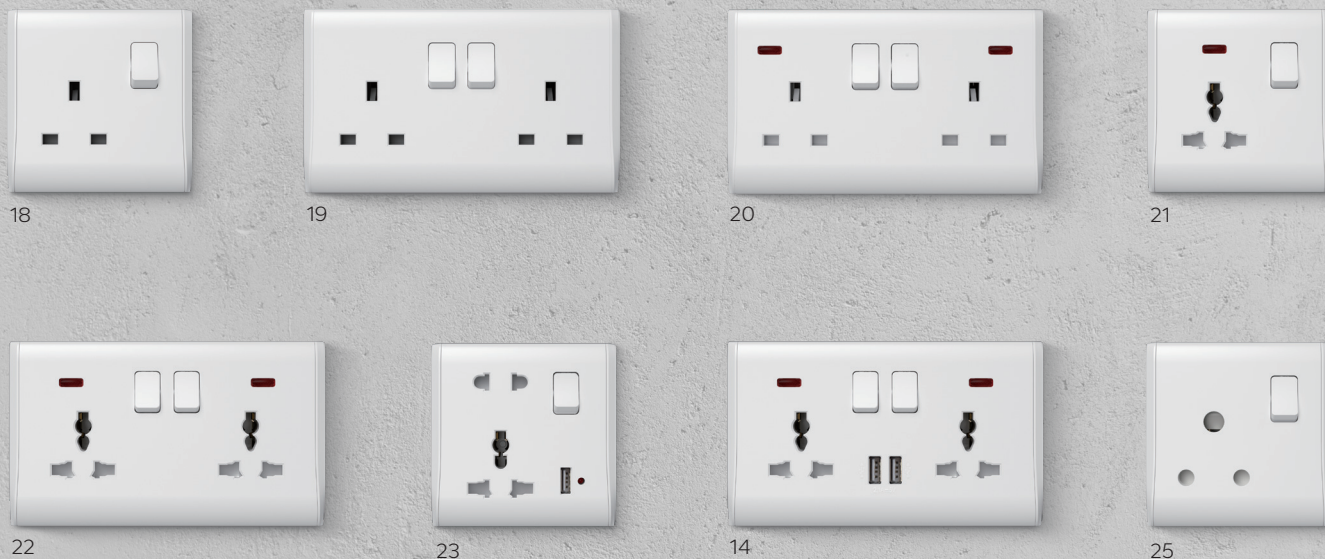

See product picture	Type	Description	Technical Data	Flush-mounted Box Dimension
<b>Socket</b>				
18	NMP605	1 gang switched socket, SP	13A	35mm
19	NMP606	2 gang switched socket, SP	13A	35mm
21	NMP607M	1 gang switched multi socket (3 pin)+ neon	13A	35mm
23	NM684	13A switched multi socket (5 pin) + neon+ 1*USB (1A)	13A	47mm
20	NMP608	2 gang switched socket, SP+neon	13A	35mm
22	NMP608M	2 gang switched multi socket (3 pin)+neon	13A	35mm
14	NMP608MB	2 gang multi switched socket + 2*USB (2.1A)	13A	47mm
25	NMP629	1 gang switched round-pin socket	15A	35mm



# Product Technical Information

## Dimensions

Dimensions for 1gang frames

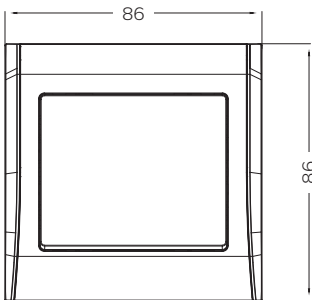

Distance between fixing screws for 1gang frames

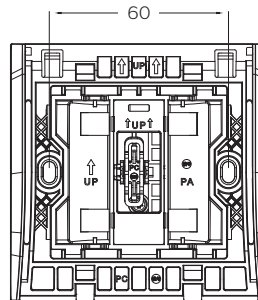

Dimensions for 2gang frames

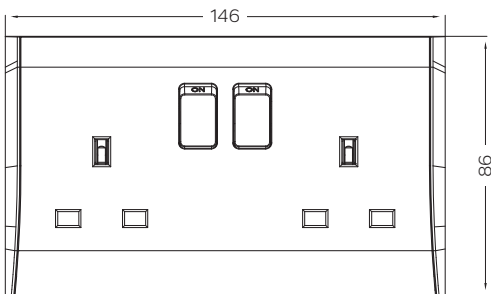

Distance between fixing screws for 2gang frames

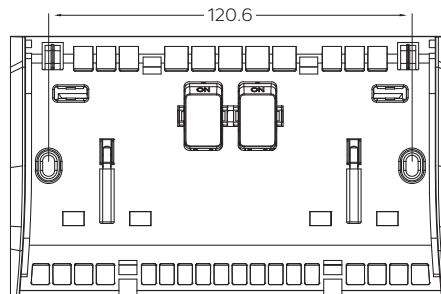

Dimensions for 1gang 45A DP switch (6x3)

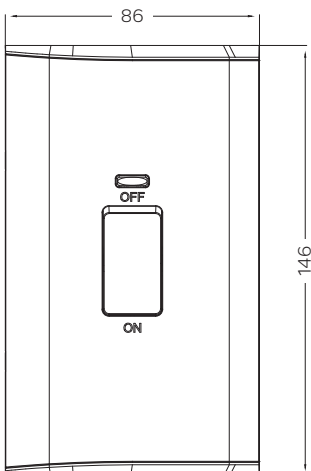

Distance between fixing screws for 45A DP switch (6x3)

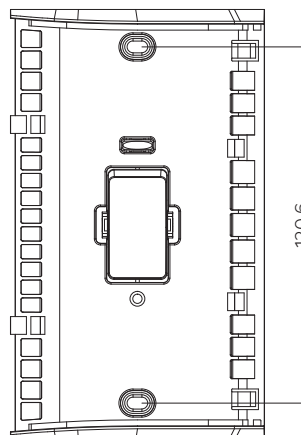

# Product Technical Information

## Wiring Diagrams

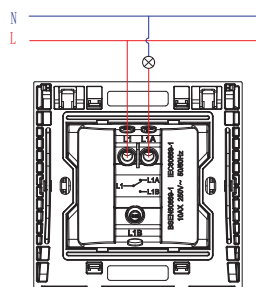

1G 1W switch

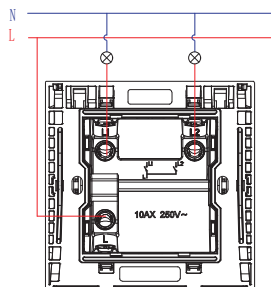

2G 1W switch

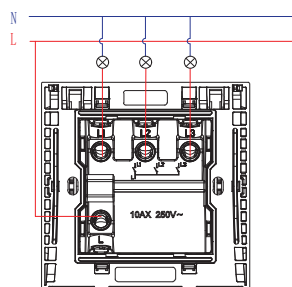

3G 1W switch

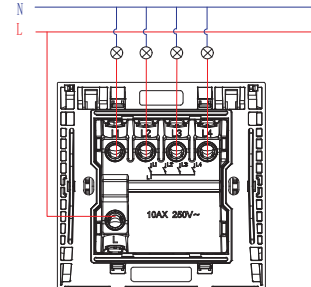

4G 1W switch

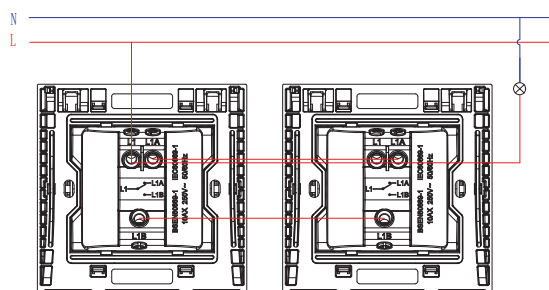

1G 2W switch

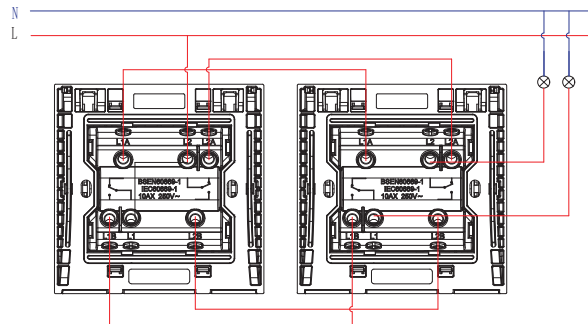

2G 2W switch

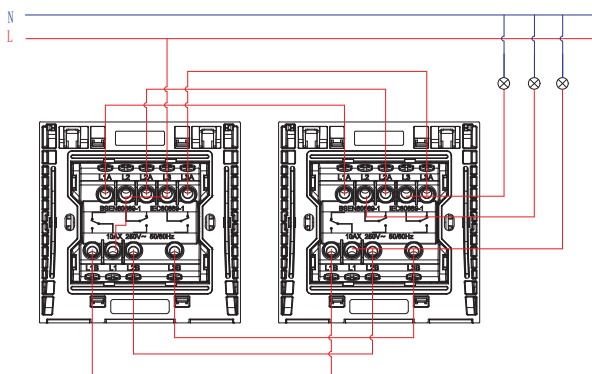

3G 2W switch

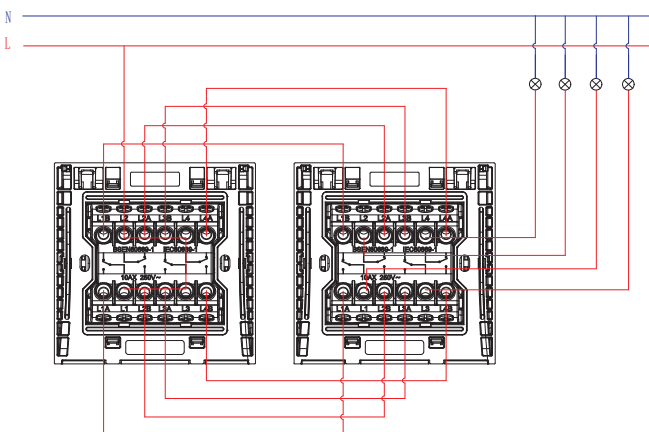

4G 2W switch

# Product Technical Information

## Wiring Diagrams

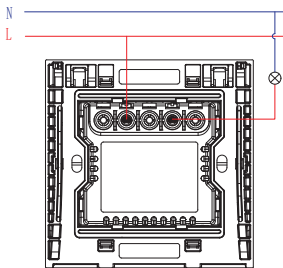

1G dimmer switch (250W)

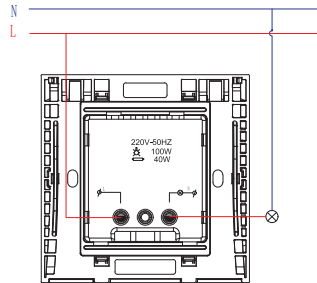

Sensor switch

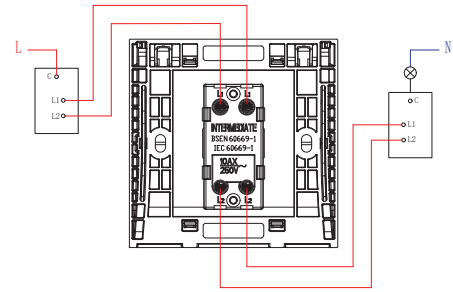

1G intermediate switch

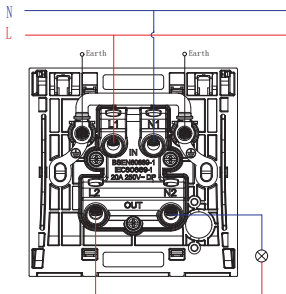

1G switch 20A DP

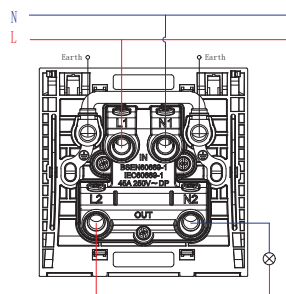

1G 45A switch DP

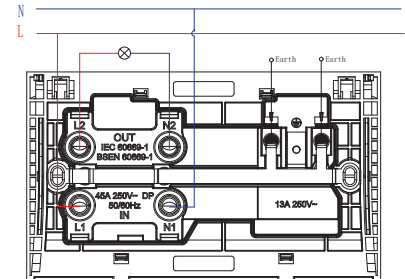

Cooker control unit

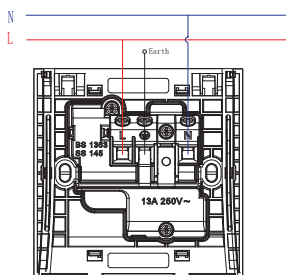

1G 13A switched socket outlet

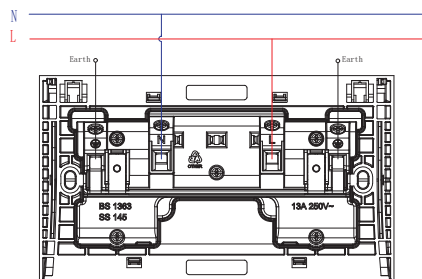

2G 13A switched socket outlet

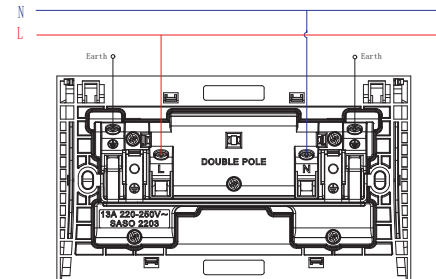

2G 13A switched socket DP



# Product Technical Information

## Wiring Diagrams

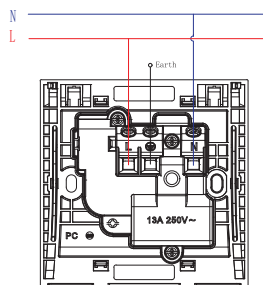

1G switched multi socket

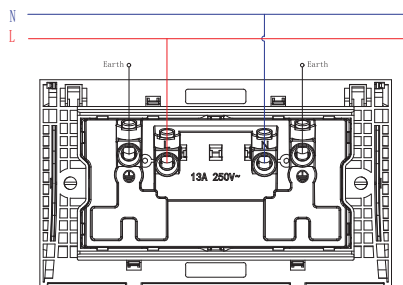

2G switched multi socket

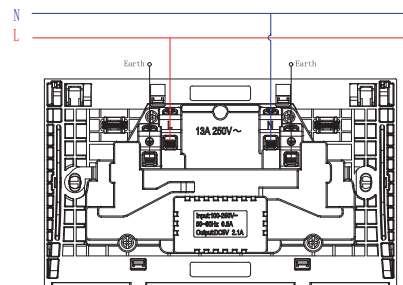

2G switched multi socket + 2\*USB

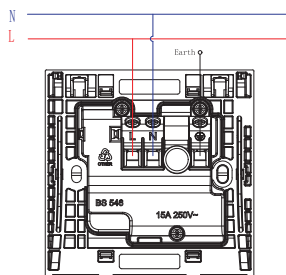

1G 15A switched socket outlet

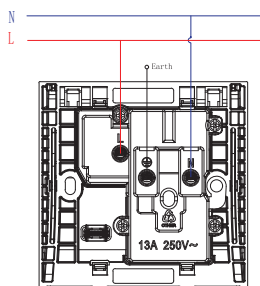

1G 13A switched multi socket + 1\*USB

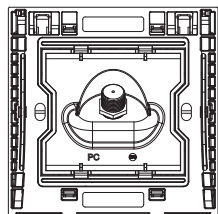

1G TV outlet

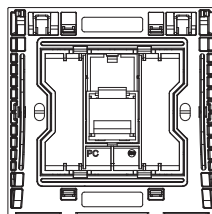

1G data outlet

### WIRING DIAGRAM

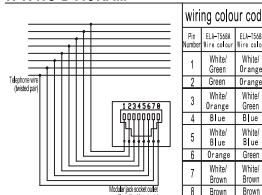

## Product Standards

Product description	Standard	Description
Switches	IEC60669-1 / BSEN60669-1	Switches for household and similar fixed electrical installations
13 A sockets	BS1363-2 / SS 145-2	Specification for 13 A switched and unswitched socket outlets
Dimmer/Fan regulator	IEC60669-2-1	Switches for household and similar fixed electrical installations
Telecommunication	BS5733	General requirements for electrical accessories
Flex outlet 20 A/45 A	BS 5733	General requirements for electrical accessories
Plates	BS 5733	General requirements for electrical accessories

Tropical® is a Registered Trade Mark of Tropical International Solutions UK Ltd.  
Akara Bldg.,24 De Castro Street,Wickhams Cay I,Road Town,Tortola, BVI, UK.  
Under NM Tropical Power [T] Ltd All rights reserved



**Tropical Power Lighting Products**  
[www.tropicalint.com](http://www.tropicalint.com)   [sales@tropicalint.com](mailto:sales@tropicalint.com)